

CON TARDI[®]

presents

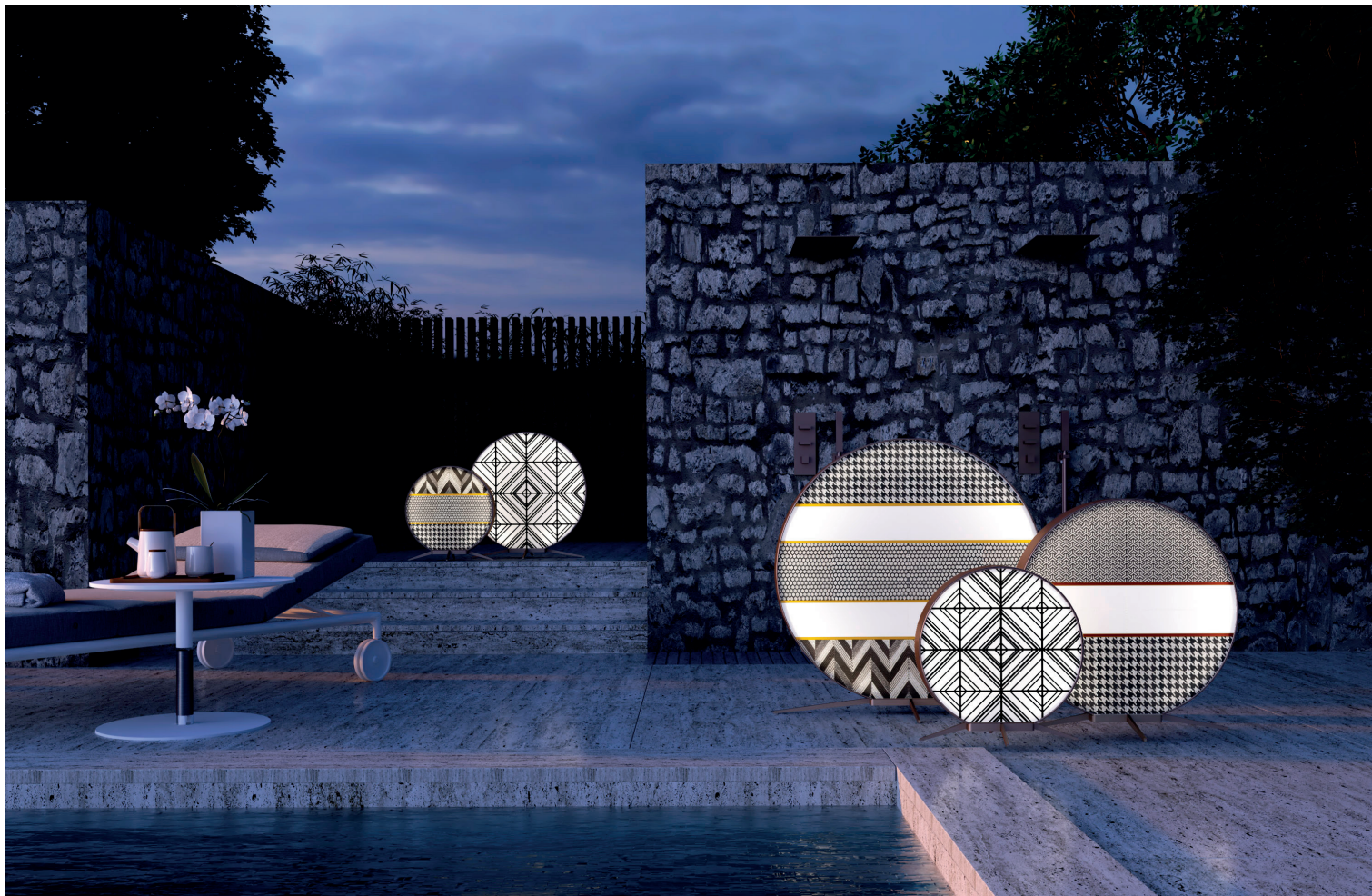

BABU
design by Massimiliano Raggi



Babu, una collezione da **esterno IP65** che unisce la funzionalità di un prodotto con fonte luminosa LED all'aspetto decorativo dato da **tessuti impermeabili** e passamanerie in velluto da esterno.

La **stampa tridimensionale** regala profondità e crea interessanti giochi ottici.

*Babu, an **IP65 outdoor** collection combining the functionality of a product with LED light source with the decorative side of the **waterproof fabrics** and the velvet trims for outdoor usage.*

*The **three-dimensional** print gives depth and creates interesting optical games.*

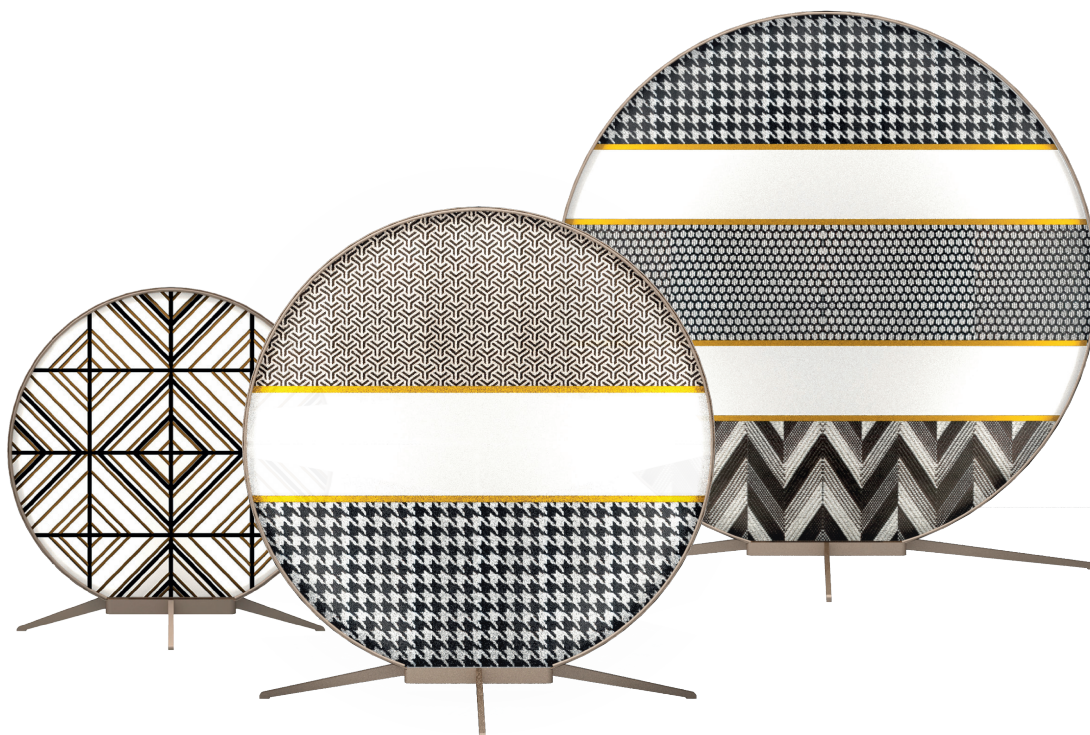



Disponibile in tre dimensioni e due varianti di trame: **Babu Tribal** e **Babu Textile** con passamanerie in velluto nelle colorazioni Orange, Bluette e Senape. La base è realizzata in acciaio laccato effetto champagne.

Available in three dimensions and two pattern types: **Babu Tribal** and **Babu Textile** with velvet trims in Orange, Bluette and Mustard Yellow. The base is made of steel, lacquered champagne effect.

TRIBAL

Colori di stampa: nero e marrone
Printing colours: black and brown

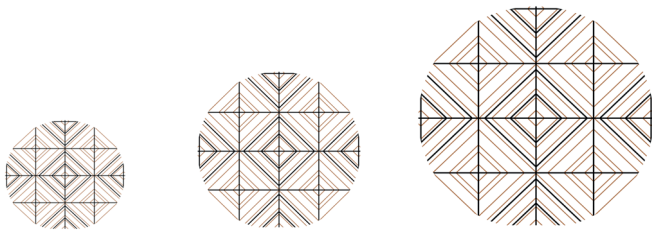

TEXTILE

Colore di stampa: nero
Printing colour: black

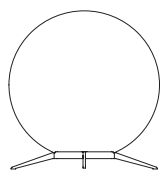
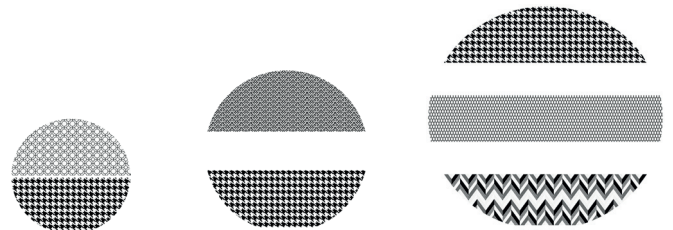

SMALL:
1x STRIP LED;
15 W/m;
1300 Lm/m;
3000K;
CRI>85

500
19.7

SMALL

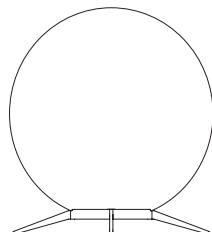

MEDIUM:
1x STRIP LED;
15 W/m;
1300 Lm/m;
3000K;
CRI>85

700
27.6

MEDIUM

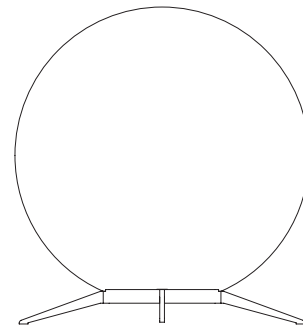

LARGE:
1x STRIP LED;
15 W/m;
1300 Lm/m;
3000K;
CRI>85

1000
39.4

LARGE

1068
42

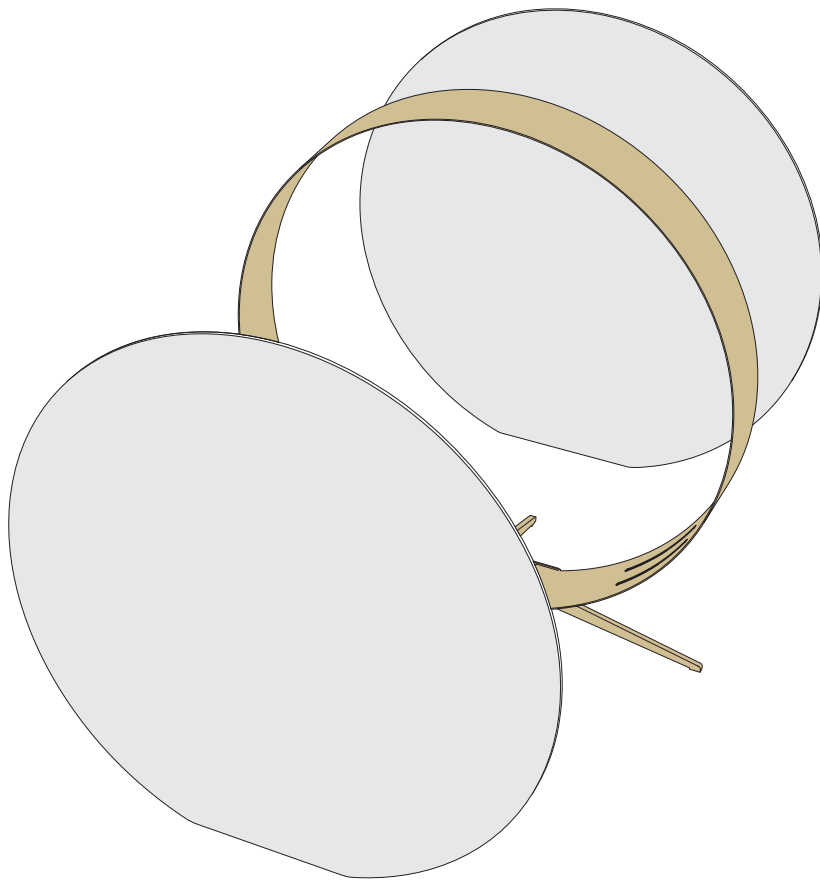

GRADO DI PROTEZIONE IP65
IP65 (WET AREAS)



TESSUTI IMPERMEABILI
WATERPROOF FABRICS

STAMPA DIGITALE 3D SU TESSUTO BIANCO
3D PRINTING ON WHITE FABRIC

PASSAMANERIE IN VELLUTO OUTDOOR
OUTDOOR VELVET TRIMS

BASE IN ACCIAIO FINITURA MARINE GRADE
STEEL BASE MARINE GRADE FINISH

ANCORAGGIO A TERRA
FLOOR ANCHORING



TRIBAL

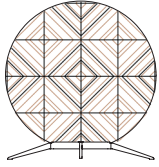

SMALL

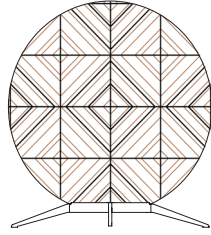

MEDIUM

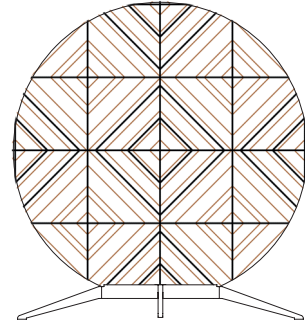



LARGE

TEXTILE



SMALL

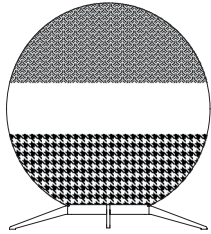

PASSAMANERIE TRIMS

-  Orange
-  Bluette
-  Senape



MEDIUM

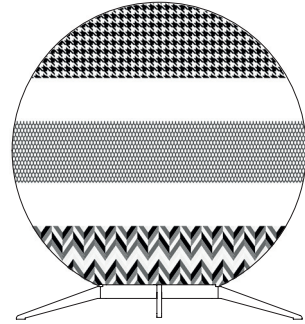

PASSAMANERIE TRIMS

-  Orange
-  Bluette
-  Senape



LARGE

PASSAMANERIE TRIMS

-  Orange
-  Bluette
-  Senape

Possibilità di **customizzare** la stampa digitale 3D, con immagini e loghi personalizzati, per un minimo di 5 pezzi per dimensione. Si suggerisce, per una migliore qualità di stampa, l'utilizzo di colori scuri.

Possibility of **customizing** the three-dimensional digital printing, with personalized images and logos, for a minimum of 5 pieces per size. The use of dark colors is suggested for better print quality.

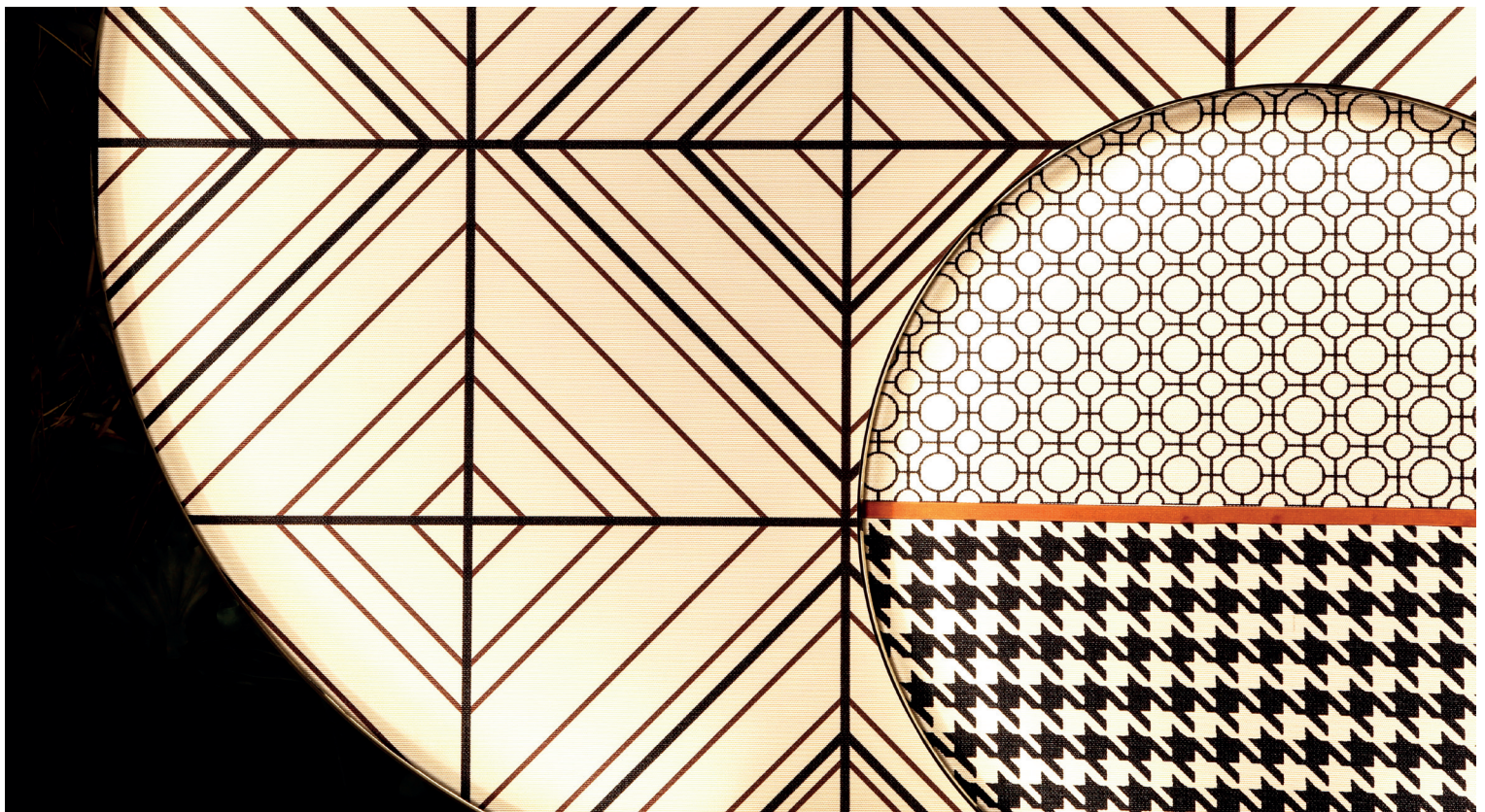



CONTARDI LIGHTING SRL
Via A. Manzoni 134/140 | 20811 Cesano Maderno (MB)
sales@contardi-italia.it | www.contardi-italia.com